

# Fire Safety Message



NY FIRE  
SAFETY INSTITUTE

NY FIRE  
CONSULTANTS, INC.



[www.nyfiresafe.com](http://www.nyfiresafe.com)

212-239-9051

[www.nyfsi.com](http://www.nyfsi.com)

January 2019

## SPACE HEATERS

The use of **kerosene or propane** space heaters is strictly prohibited and illegal in New York City. The use of these types of space heaters poses a high risk of death and injury



Kerosene Heater

### ELECTRIC SPACE HEATERS

When purchasing an electric space heater, look for heaters with automatic shut-off features. Never use the kitchen oven or gas range to heat your home or apartment. Such improper use could cause dangerous levels of carbon monoxide to accumulate, causing severe illness and possible death.



Read the manufacturer's instructions and warning labels before using your portable electric heater.

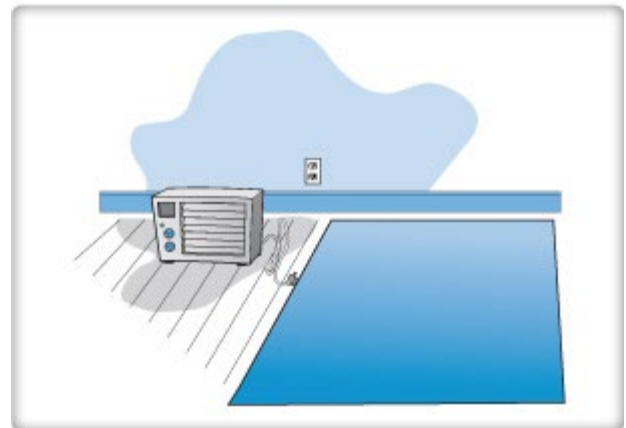

**DO NOT** leave operating heater unattended and always unplug heater when not in use

## New Classes Added

Sprinkler/Standpipe Certificate of Fitness Preparation January 16<sup>th</sup> @ 8:30 am  
Coordinator of Fire Safety & Alarm Systems, January 28<sup>th</sup> @ 8:30 am  
Construction Site Fire Safety Manager, F-56 February 11<sup>th</sup> and 13<sup>th</sup> @ 4:30 pm

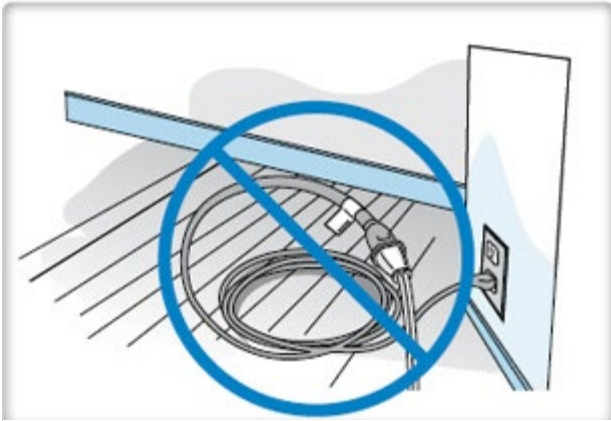

**DO NOT** use your heater with a power strip or extension cord. Overheating of a power strip or extension cord could result in a fire.

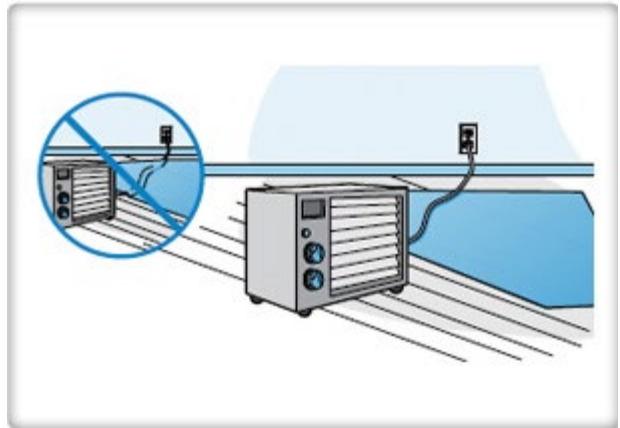

String out cords on top of area rugs or carpeting. Placing anything, including furniture, on top of the cord may damage it.

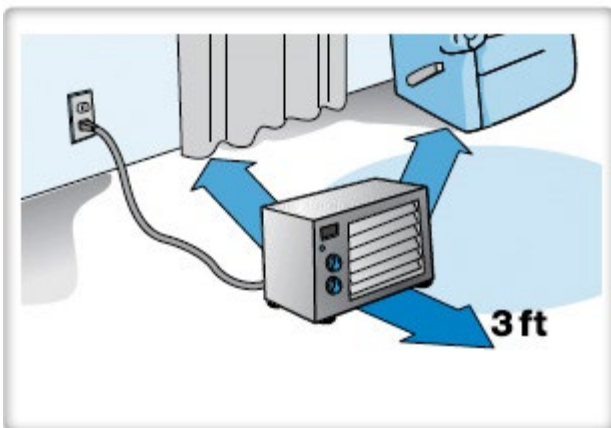

Keep flammable materials away from the heater.

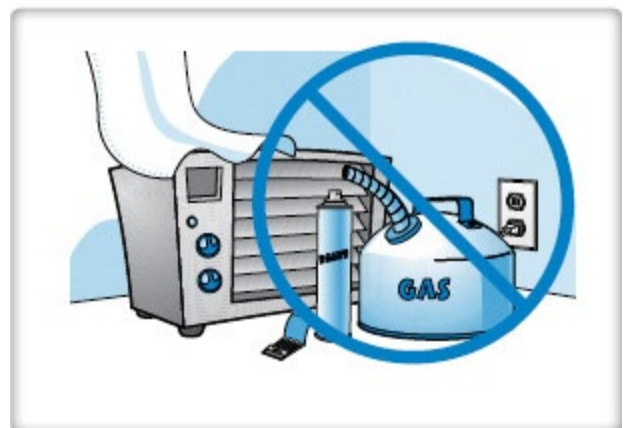

Keep combustible materials, such as furniture, pillows, bedding, papers, clothes and curtains at least three feet from the front of the heater and away from the sides and rear. **DO NOT** block heater's air intake or exhaust source.



Unless the heater is designed for outdoor use or in bathrooms, **DO NOT** use in damp or wet areas. Parts in the heater may be damaged by moisture.

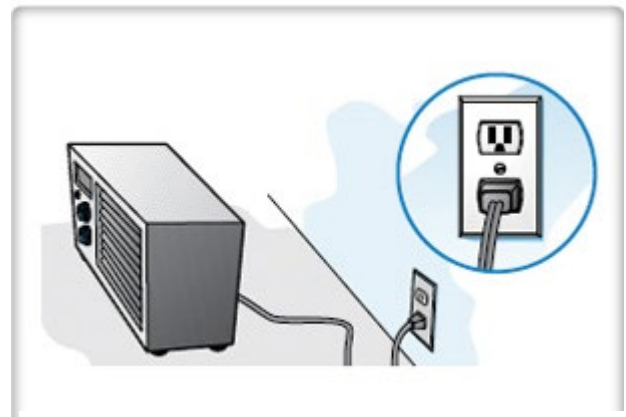

Check periodically for a secure plug/outlet fit. If the plug does not fit snugly into the outlet or if the plug becomes very hot, the outlet may need to be replaced. Check with a qualified electrician to replace the outlet.



Unplug the heater when not in use by pulling the plug straight out from the outlet. Inspect the heater's cord periodically. **DO NOT** use a heater with a damaged cord.

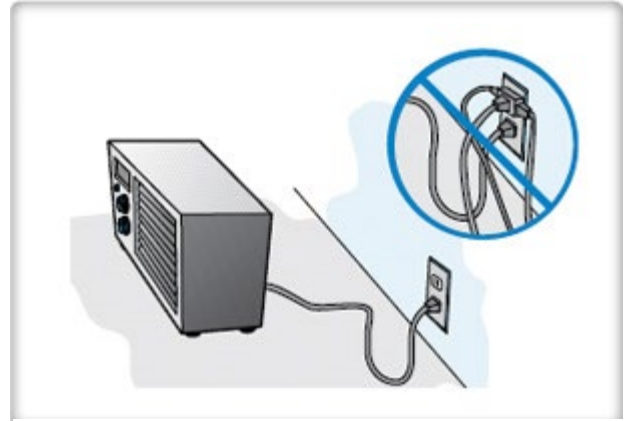

**DO NOT** plug any other electrical device into the same outlet as your heater. This could result in overheating.

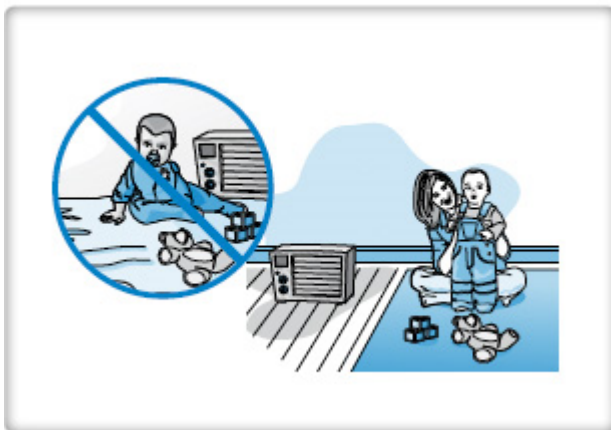

Heaters should be kept away from children and not be placed in a child's room without supervision.

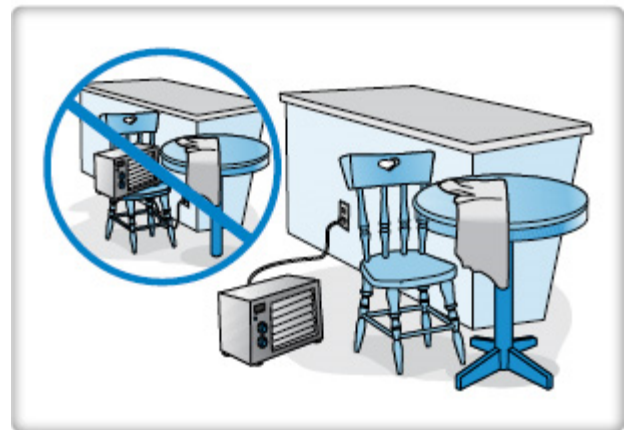

Place heater on a level, flat surface. Only use heater on table tops when specified by the manufacturer. **DO NOT** place your heater on furniture. It could fall, dislodging or breaking parts in the heater.



## Fire Safety Logbooks

**A new logbook must be started each calendar year**

The Fire Code and the Rules of the City of New York outline the requirements for several logbooks to be maintained by Building Management. The Bureau of Fire Prevention has set guidelines for logbook record keeping. An inspection of the logbooks is performed annually by the New York City Fire Department Hi-Rise Unit.

**Keep up-to-date log entries of required system inspections and tests to avoid violations.**

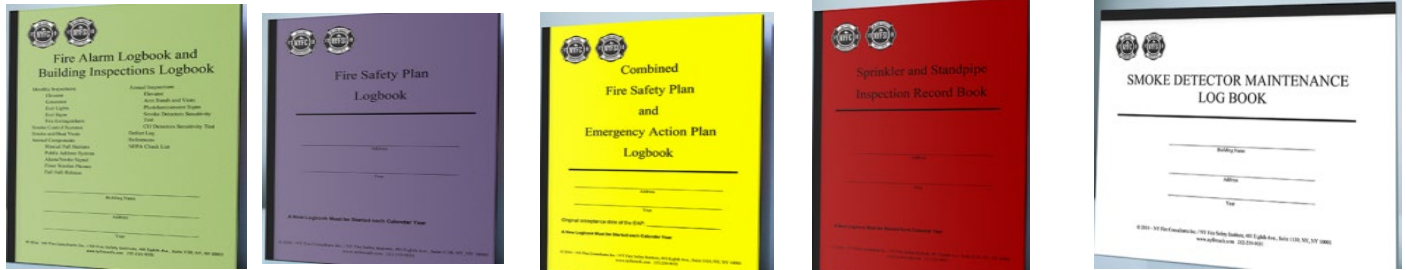

**Fire Alarm/Building Inspection Logbook \$78.00 plus Sales Tax \$6.92 Total \$84.92**

- Fire Alarm Book: Daily Log, Fire Alarm Incidents, On Off Line Log
- Monthly Inspections: Elevator, Generator, Exit Lights, Exit Signs, Fire Extinguishers
- Semi-Annual Inspections: Manual Pull Stations, Public Address System, Alarm/Strobe Signal, Floor Warden Phones, Fail-Safe Release
- Annual Inspections: Arm Bands and Vests, Photoluminescent Signs
- NFPA Inspection Check List

**Fire Safety Plan Logbook \$55.00 plus Sales Tax \$4.88 Total \$59.88**

- Daily Fire Safety Director Log, Fire Safety & Evacuation Drills, Fire Safety & Training,
- Fire Safety Plan Onsite Practical Test, Fire Safety Plan Reviews & Amendments, Fire Protection System Contractors, Reference Material

**Combination Fire Safety /EAP Logbook \$91.00 plus Sales Tax \$8.08 Total \$99.08**

- Daily Fire Safety/EAP Director Log, Drills & Training, Emergency Action Plan - Related Events, Drills & Training Sessions, Fire Safety/Emergency Action Plan Onsite Practical Test & Plan Reviews & Amendments, Voluntary EAP Full Building Evacuation Drills, Fire Protection System Contractors, Reference Material

**Sprinkler & Standpipe Inspection Record Book \$46.00 plus Sales Tax \$4.08 Total \$50.08**

- Fire Pump Testing, Weekly, Annual - Water Storage Tank, During the Heating Season
- Monthly Sprinkler Inspection Record & Monthly Standpipe Inspection Record
- Sprinkler and Standpipe Deficiencies Record
- National Fire Protection Association (NFPA), Inspections, Testing and Maintenance

**Smoke Detector Maintenance Record \$41.00 plus Sales Tax \$3.64 Total \$44.64**

- Semi Annual Smoke Detector Cleaning, Annual Sensitivity Test Records, Smoke Detector Repair or Replacement Records

**Homeless Shelter Drills & Training Record \$57.00 plus Sales Tax \$5.06 Total \$62.06**

- Daily Coordinator Fire Safety/Alarm Systems Log - Homeless Shelter Drills - Fire & Emergency Preparedness (FEP) Staff Training - Emergency Preparedness Plan Reviews & Amendments

**Order your logbooks today at [www.nyfiresafe.com/products](http://www.nyfiresafe.com/products) Then tab LOGBOOKS.**

**Next  
FLSD Class  
Starts Feb. 5, 2019**

**Next  
EAP Class  
Jan. 24<sup>th</sup> & 29<sup>th</sup>  
2019**

**Next Saturday  
FSD Class Starts  
Feb 16, 2019**

## **5 Teens Die in Poland Escape Room Fire**

Five teenage girls died, and one man was seriously injured when a fire broke out in a room where they were playing an escape game Poland.

In "escape rooms", participants are locked in a room and race against the clock to solve puzzles and challenges to open a way out.



**Next  
Active Shooter Class  
Starts Jan. 30, 2019**

**Next  
Sprinkle/Standpipe  
Class  
Jan. 16, 2019**

**Next  
F-80 Class  
Jan. 28, 2019**



**NY FIRE SAFETY INSTITUTE** WYNDHAM NEW YORKER HOTEL, 481 EIGHTH AVENUE,  
SUITE 618, (8TH AVENUE AT WEST 34<sup>th</sup> STREET) (718) 432-1600 OR (212) 239-9051